

ELKO EP, s.r.o.
 Palackého 493
 769 01 Holešov, Vsetuly
 Czech Republic
 Tel.: +420 573 514 211
 e-mail: elko@elkoep.com
 www.elkoep.com

Made in Czech Republic



ATS-2D, ATS-2DR, ATS-2WR

Analog time switch
 with daily/weekly program



Characteristics

- The mechanical time switch is a simple and inexpensive alternative to digital time switches for controlling heating, ventilation, cooling, lighting systems or pumps depending on real time.
- Power reserve after power off for up to 150 hours after fully charged.
- Sealable transparent front panel cover.
- The ATS-2DR package includes a plastic DIN rail.
- Selection of operating modes using the switch on the panel:

ATS-2D, ATS-2WR

- switches automatically according to the set program
- I** permanently closes
- O** permanently opens

ATS-2DR

- I** permanently closes
- II** switches automatically according to the set program

Connection

ATS-2D, ATS-2WR 16 (4)A 250 V 230 V 50/60 Hz

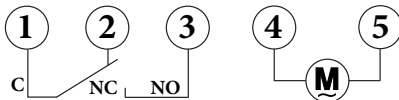

ATS-2DR 16 (4)A 250 V 230 V 50/60 Hz

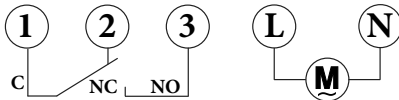

Setting

Minimum switching interval:

- daily 30 minutes (1 segment)
- weekly 210 minutes (1 segment)

High temperatures can affect the accuracy of the time switches

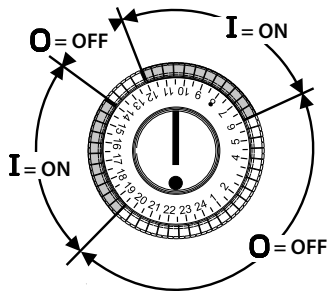

Example:
 06:00 ... 12:00 ON
 12:00 ... 14:00 OFF
 14:00 ... 19:30 ON
 19:30 ... 06:00 OFF

ATS-2D, ATS-2WR

Lower the segments all the way down

ATS-2DR

Lower the segments all the way down

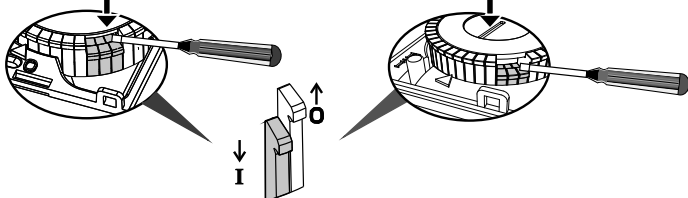

Description

ATS-2D, ATS-2WR

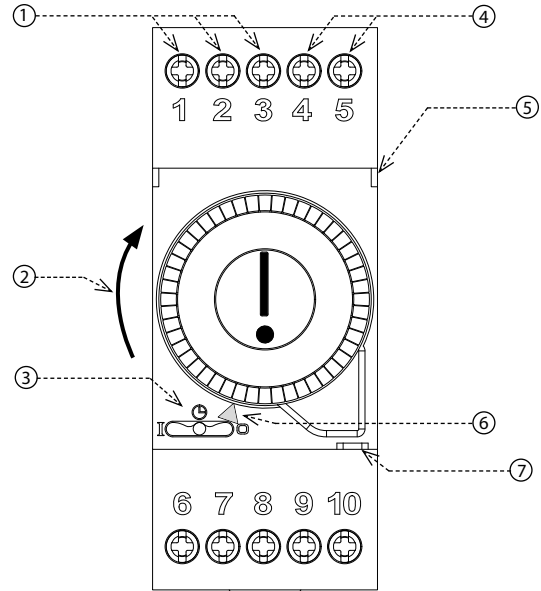

- Output contact (1-2-3)
- Rotation of the programming dial
- Operating mode switch
- Supply voltage terminals (4-5)
- Transparent opening cover
- Time indicator
- Sealing spot

ATS-2DR

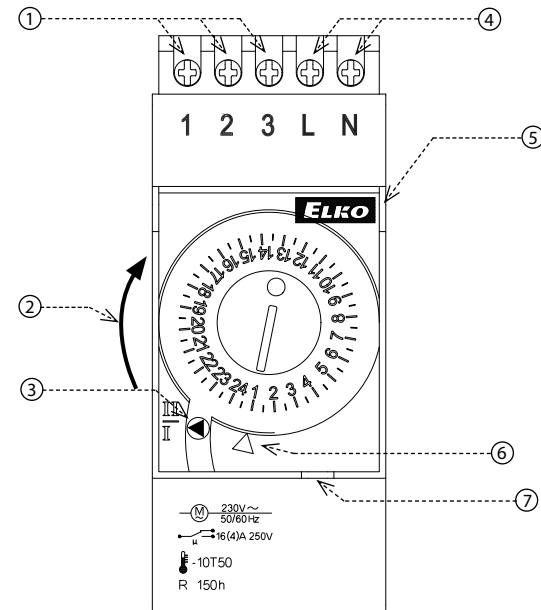

- Output contact (1-2-3)
- Rotation of the programming dial
- Operating mode switch
- Supply voltage terminals (L - N)
- Transparent opening cover
- Time indicator
- Sealing spot

Operating mode

- 1 switches automatically according to the set program
- 2 permanently closes
- 3 permanently opens

ATS-2D, ATS-2WR

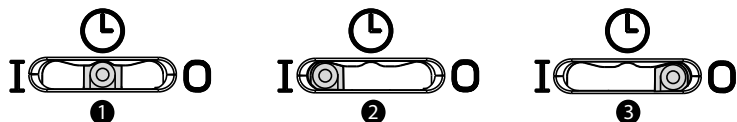

ATS-2DR

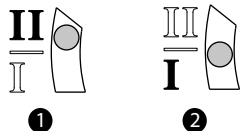

Power reserve (models only ATS-2DR, ATS-2WR)

The time switch starts working approx. 5 minutes after being connected to the power supply. After approximately 72 hours from the connection to the power supply, the power reserve reaches it's complete charge of 150 hours.

Technical parameters

	ATS-2D	ATS-2DR	ATS-2WR
Supply			
Supply terminals:	4-5	L-N	4-5
Supply voltage:	AC 230 V (50/60 Hz)		
Consumption (max.):	1.6 VA/1 W		
Supply voltage tolerance:	-10%; +10%		
Time circuit			
Program:	daily	daily	weekly
Number of switching segments:	48		
Minimum switching interval:	30 mins	30 mins	3.5 hrs
Operating accuracy:	±2 s/day		
Power reserve:	×	max. 150 hod	
Output			
Contact type:	1x changeover (AgNi)	1x changeover (AgCdO15)	1x changeover (AgNi)
Rated current:	16 A/AC1		
Breaking capacity:	3500 VA/AC1		
Switching voltage:	250 V AC		
Mechanical life:	2.000.000 ops.	100.000 ops.	2.000.000 ops.
Electrical life (AC1):	100.000 ops.	30.000 ops.	100.000 ops.
Other information			
Operating temperature:	-10 .. +50 °C (14 .. 122 °F)		
Storage temperature:	-10 .. +50 °C (14 .. 122 °F)		
Dielectric strength:	AC 4 kV (supply – output)		
Operating position:	any		
Mounting:	DIN rail EN 60715		
Protection degree:	IP20		
Overvoltage category:	III.		
Pollution degree:	2		
Cross-wire section – solid/stranded with ferrule (mm²):	max. 1x 4, 2x 1.5/ max. 1x 4, 2x 1.5 (AWG 12)		
Dimensions:	91 x 36 x 61 mm (3.6" x 1.4" x 2.4")		
Weight:	120 g (4.25 oz)		
Standards:	EN 61812-1, EN 60730-1		

Time setting - daily program

Do not turn counter clockwise

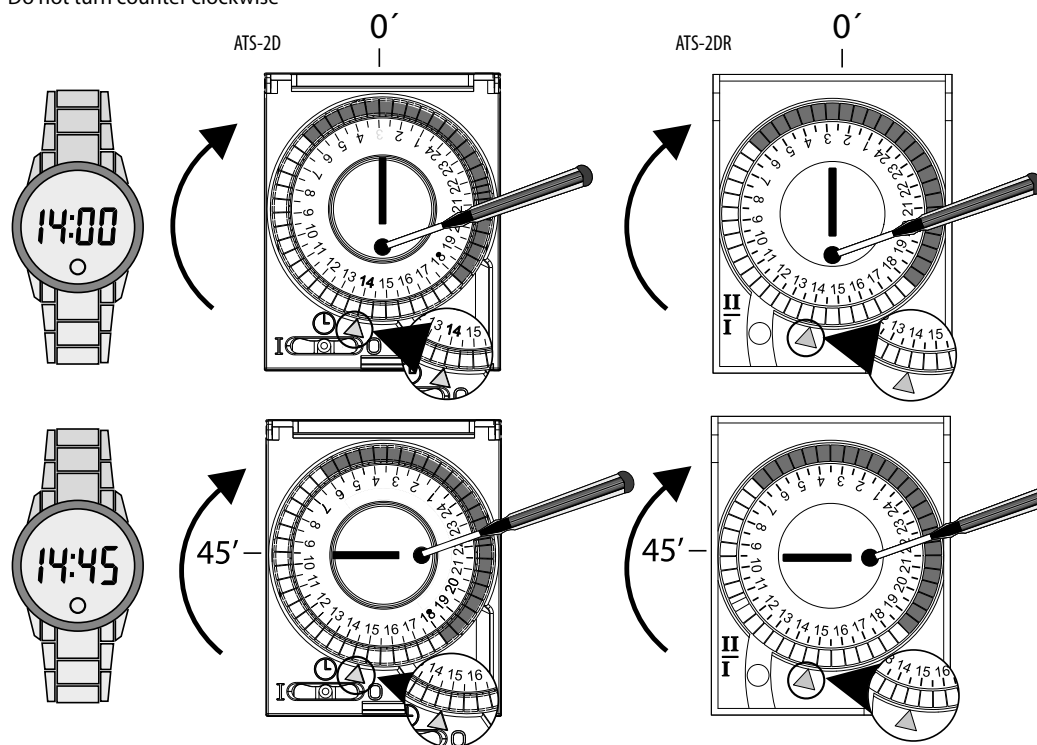

Day / time setting - weekly program

Do not turn counter clockwise

ATS-2WR

Example: 3 = Wednesday, 2:45 p.m.

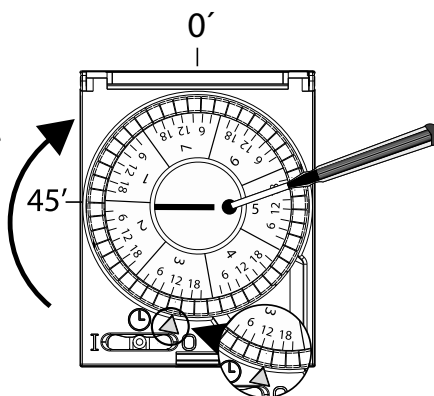

Warning

This device is constructed for connection in 1-phase network AC 230 V and must be installed according to norms valid in the state of an application. Installation, connection, setting and servicing must be carried out by qualified electrician staff only, which have perfectly understood the instructions and functions of the device. This device contains protection against overvoltage peaks and disturbing impulses in the power supply network. For the correct function of the protection of this device, there must be suitable protections of higher degrees (A,B,C) installed in front of them and according to the standards, interference of switching devices must be securely eliminated (contactors, motors, inductive loads, etc.). Before installation, make sure that the device is de-energized and the main switch is in the "OFF" position. Don't install the device to sources of excessive electromagnetic interference. Ensure correct installation by perfect air circulation so that during continuous operation and a higher ambient temperature, the device does not exceed the maximum allowed operating temperature. For installation and setting use a screwdriver with a width of approx 2 mm. Keep in mind that this is a fully electronic device and approach accordingly with the installation. Non-problematic function of the device is also dependent on the previous method of transportation, storage, and handling. In case of any signs of damage, deformation, malfunction, or missing parts, don't install this device and claim it at the dealer. The product must be treated as electronic waste at the end of its life.